

STIHL[®]

STIHL BG 56, 66, 86, SH 56, 86

Instruction Manual



Contents

Guide to Using this Manual	2
Safety Precautions and Working Techniques	2
Assembling the Blower	8
Assembling the Vacuum Shredder	9
Fuel	11
Fueling	12
Starting / Stopping the Engine	13
Cleaning the Air Filter	15
Adjusting the Carburetor	16
Spark Plug	17
Engine Running Behavior	18
Storing the Machine	19
Inspections and Maintenance by Dealer	19
Maintenance and Care	20
Main Parts	22
Specifications	23
Maintenance and Repairs	24
Disposal	25
EC Declaration of Conformity	25

Dear Customer,

Thank you for choosing a quality engineered STIHL product.

It has been built using modern production techniques and comprehensive quality assurance. Every effort has been made to ensure your satisfaction and troublefree use of the product.

Please contact your dealer or our sales company if you have any queries concerning this product.

Your



Dr. Nikolas Stihl

STIHL®

This instruction manual is protected by copyright. All rights reserved, especially the rights to reproduce, translate and process with electronic systems.

Guide to Using this Manual

Pictograms

The meanings of the pictograms attached to the machine are explained in this manual.

Depending on the model concerned, the following pictograms may be attached to your machine.



Fuel tank; fuel mixture of gasoline and engine oil

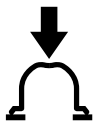

Operate manual fuel pump

Symbols in text



WARNING

Warning where there is a risk of an accident or personal injury or serious damage to property.



NOTICE

Caution where there is a risk of damaging the machine or its individual components.

Engineering improvements

STIHL's philosophy is to continually improve all of its products. For this reason we may modify the design, engineering and appearance of our products periodically.

Therefore, some changes, modifications and improvements may not be covered in this manual.

Safety Precautions and Working Techniques



Special safety precautions must be observed when working with a power tool.



It is important that you read the instruction manual before first use and keep it in a safe place for future reference. Non-observance of the instruction manual may result in serious or even fatal injury.

Observe all applicable local safety regulations, standards and ordinances.

If you have not used this model before: Have your dealer or other experienced user show you how to operate your machine or attend a special course in its operation.

Minors should never be allowed to use this product.

Keep bystanders, especially children, and animals away from the work area.

When the power tool is not in use, put it in a place where it does not endanger others. Secure it against unauthorized use.

The user is responsible for avoiding injury to third parties or damage to their property.

Do not lend or rent your power tool without the instruction manual. Be sure that anyone using your power tool understands the information contained in this manual.

The use of noise emitting power tools may be restricted to certain times by national or local regulations.

Do not operate your unit if any of its components are damaged.

Do not use a pressure washer to clean the unit. The solid jet of water may damage parts of the unit.

Accessories and Spare Parts

Only use parts and accessories that are explicitly approved for this power tool by STIHL or are technically identical. If you have any questions in this respect, consult a servicing dealer. Use only high quality parts and accessories in order to avoid the risk of accidents and damage to the unit.

STIHL recommends the use of genuine STIHL replacement parts. They are specifically designed to match the product and meet your performance requirements.

Never attempt to modify your power tool in any way since this may increase the risk of personal injury. STIHL excludes all liability for personal injury and damage to property caused while using unauthorized attachments.

Physical Condition

To operate this power tool you must be rested, in good physical condition and mental health.

If you have any condition that might be aggravated by strenuous work, check with your doctor before operating a power tool.

Persons with pacemakers only: The ignition system of your power tool produces an electromagnetic field of a very low intensity. This field may interfere with some pacemakers. To reduce health risks, STIHL recommends that persons with pacemakers consult their physician and the pacemaker manufacturer before operating this power tool.

Do not operate the power tool if you are under the influence of any substance (drugs, alcohol) which might impair vision, dexterity or judgment.

Intended Use

The blower is designed for blow-sweeping leaves, grass, paper and similar materials, e.g. in gardens, sports stadiums, car parks and driveways. It is also suitable for blow-sweeping forest paths.

The vacuum shredder is designed for picking up dry leaves and other lightweight, loose and non-combustible materials.

Do not blow-sweep or vacuum hazardous materials.

Do not use the power tool for any other purpose because of the increased risk of accidents and damage to the power tool itself. Never attempt to modify the product in any way since this may result in accidents or damage to the product.

Clothing and Equipment

Wear proper protective clothing and equipment.



Clothing must be sturdy but allow complete freedom of movement. Wear snug-fitting clothing, an overall and jacket combination, do not wear a work coat.



Avoid any clothing, scarves, neckties, jewelry or anything that could get into the air intake. Tie up and confine long hair (e.g. with a hair net, cap, hard hat, etc.).

Wear sturdy shoes with non-slip soles.



WARNING



To reduce the risk of eye injuries, wear snug-fitting safety glasses in accordance with European Standard EN 166. Make sure the safety glasses are a good fit.

Wear hearing protection, e.g. earplugs or ear muffs.

STIHL offers a comprehensive range of personal protective clothing and equipment.

Transporting the Unit

Always stop the engine.

Transporting in a vehicle:

- Properly secure your power tool to prevent turnover, fuel spillage and damage.

Fueling



Gasoline is an extremely flammable fuel. Keep clear of naked flames. Do not spill any fuel – do not smoke.

Always **shut off the engine** before refueling.

Do not fuel a hot engine – **fuel may spill and cause a fire.**

Open the fuel cap carefully to allow any pressure build-up in the tank to release slowly and avoid fuel spillage.

Fuel your power tool only in well-ventilated areas. If you spill fuel, wipe the machine immediately – if fuel gets on your clothing, change immediately.



Check for leakage. To reduce the **risk of serious or fatal burn injuries**, do not start or run the engine until leak is fixed.



After fueling, tighten down the screw-type fuel cap as securely as possible.

This reduces the risk of unit vibrations causing the fuel cap to loosen or come off and spill quantities of fuel.

Before Starting

Check that your power tool is properly assembled and in good condition – refer to appropriate chapters in the instruction manual.

- Check the fuel system for leaks, paying special attention to visible parts such as the tank cap, hose connections and the manual fuel pump (on machines so equipped). If there are any leaks or damage, do not start the engine – **risk of fire**. Have your machine repaired by a servicing dealer before using it again.
- Throttle trigger must move freely and spring back to the idle position when released.
- Setting lever/switch must move easily to **STOP** or **0**
- Keep the handles dry and clean – free from oil and dirt – for safe control of the power tool.
- The blower tubes must be properly assembled.
- Check that the spark plug boot is secure – a loose boot may cause arcing that could ignite combustible fumes **and cause a fire**.
- Check condition of blower wheel and blower housing.

A worn blower housing (cracks, nicks, chips) may result in an increased risk of injury from thrown foreign objects. If the blower housing is damaged, consult your dealer – STIHL recommends you contact a STIHL servicing dealer.

Never attempt to modify the controls or the safety devices in any way.

To reduce the risk of accidents, do not operate the unit if it is not properly assembled and in good condition.

Starting the Engine

Start the engine at least 3 meters from the fueling spot, outdoors only.

Your power tool is designed to be operated by one person only. Do not allow other persons in the work area – even when starting.

Do not drop start the power tool – start the engine as described in the instruction manual.

Place the power tool on level ground, make sure you have secure footing, hold the power tool securely.

As soon as the engine starts, the air flow may throw small objects (e.g. stones) in your direction.

During Operation

In the event of impending danger or in an emergency, switch off the engine immediately by moving the setting lever / switch to **STOP** or **0**.

Your power tool is designed to be operated by one person only. Do not allow other persons in the work area.

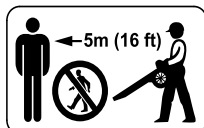

To reduce the risk of injury from thrown objects, do not allow any other persons within a radius of 5 meters of your own position.

To reduce the risk of damage to property, also maintain this distance from other objects (vehicles, windows).



Do not direct the air blast towards bystanders or animals since the air flow can blow small objects at great speed – **risk of injury**.

When blow-sweeping and vacuum shredding (in open ground and gardens), watch out for small animals to avoid harming them.

Never leave a running machine unattended.

Take special care in slippery conditions, on slopes or uneven ground.

Watch out for obstacles: Be careful of refuse, tree stumps, roots and ditches which could **cause you to trip or stumble**.

Never work on a ladder or any other insecure support.

Be particularly alert and cautious when wearing hearing protection because your ability to hear warnings (shouts, alarms, etc.) is restricted.

Work calmly and carefully – in daylight conditions and only when visibility is good. Stay alert so as not to endanger others.

To reduce the risk of accidents, take a break in good time to avoid tiredness or exhaustion.

Mufflers with a catalytic converter can become particularly hot.



Your power tool produces **toxic exhaust fumes** as soon as the engine is running. These fumes may be colorless and odorless and contain unburned hydrocarbons and benzol. Never run the engine indoors or in poorly ventilated locations, even if your model is equipped with a catalytic converter.

To reduce the risk of serious or fatal injury from breathing toxic fumes, ensure proper ventilation when working in trenches, hollows or other confined locations.

To reduce the risk of accidents, stop work immediately in the event of nausea, headache, visual disturbances (e.g. reduced field of vision), problems with hearing, dizziness, deterioration in ability to concentrate. Apart from other possibilities, these symptoms may be caused by an excessively high concentration of exhaust gases in the work area.

To reduce the risk of fire, do not smoke while operating or standing near your power tool. Note that combustible fuel vapor may escape from the fuel system.

If dust levels are very high, always wear a suitable respirator.

Operate your power tool so that it produces a minimum of noise and emissions – do not run the engine unnecessarily, accelerate the engine only when working.

After finishing work, put the unit down on a level, non-flammable surface. **To reduce the risk of fire**, do not put it down near easily combustible materials (e.g. wood chips, bark, dry grass, fuel).

Never attempt to insert objects into the blower housing through the intake screen or the nozzle. They may be expelled at very high speed by the blower – **risk of injury**.

If there is a noticeable change in running behavior (e.g. higher vibrations), stop work and rectify the cause of the problem.

If your power tool is subjected to unusually high loads for which it was not designed (e.g. heavy impact or a fall), always check that it is in good condition before continuing work – see also "Before Starting Work". Check the fuel system in particular for leaks and make sure the safety devices are working properly. Do not continue operating your power tool if it is damaged. In case of doubt, consult your servicing dealer.

Using the Blower

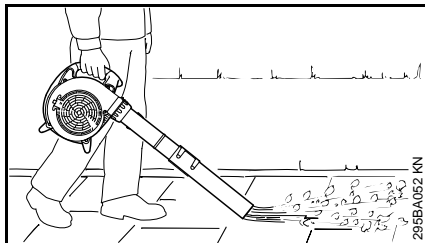

Your blower is designed for one-handed operation. It must be carried by the control handle in the right hand.

Always hold the power tool firmly in your hand.

Watch out for small animals when using the blower on open ground, in yards and gardens.

Walk slowly forwards as you work – observe the nozzle outlet at all times – do not walk backwards – **risk of stumbling.**



WARNING

To reduce the risk of injury, operate the unit only with a properly mounted blower tube.

The round nozzle is particularly suitable for use on uneven surfaces (e.g. fields and lawns).

The fan nozzle (either included with power tool or available as special accessory) produces a broad and powerful airstream at ground level. It can be aimed and controlled very accurately. This nozzle is highly effective for blow-sweeping sawdust, leaves, grass cuttings, etc. on flat surfaces.

Using the Vacuum Attachment

For specific assembling instructions, see appropriate chapter in this manual.



Your vacuum shredder is designed for two-handed operation. Hold and operate the unit with your right hand on the control handle and your left hand on the assist handle.

Wear the catcher bag shoulder strap over your left shoulder, not across your chest. This enables you to quickly remove the power tool and catcher bag in an emergency.

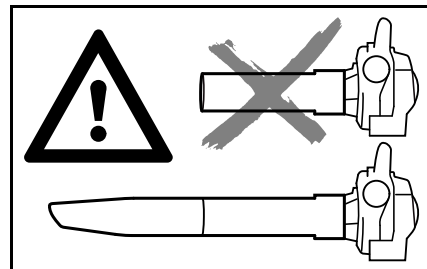

WARNING

To reduce the risk of injury, operate your power tool only with a properly mounted suction tube and closed catcher bag.



NOTICE

Vacuuming abrasive material (such as grit, stone chips, etc.) causes the blower wheel and blower housing to wear at a rapid rate. This results in a considerable loss of suction power. In such a case you should contact your dealer. STIHL recommends an authorized STIHL servicing dealer.

Take particular care when vacuuming wet leaves since they may block the blower wheel and elbow.

Watch out for small animals when using the vacuum on open ground, in yards and gardens.



To reduce the risk of personal injury from fire, never attempt to pick up hot or burning substances (e.g. smoldering ashes, glowing cigarettes).



To reduce the risk of fatal injury from fire or explosion, never attempt to pick up combustible fluids (e.g. gasoline) or materials soaked in combustible fluids.



Switch off the engine before opening the intake screen. The intake screen must always be closed and secured when the suction tube is not mounted to reduce the risk of injury from contact with rotating components. This can also result in damage to the engine.

Working Technique

To minimize blowing time, use a rake and broom to loosen dirt particles before you start blowing.

Recommended working technique to minimize air pollution:

- If necessary, dampen the surface to be cleaned in order to avoid creating too much dust.
- Do not blow particles in the direction of bystanders, in particular in the direction of children, pets, open windows or freshly washed vehicles. Take special care in such situations.
- Remove the blow-swept debris in rubbish bins – do not blow it onto the neighbor's land.

Recommended working technique to minimize noise:

- Operate your power tool at reasonable times only – not early in the morning, late at night or during midday rest periods when people could be disturbed. Observe local rest periods.
- Operate blowers at the lowest engine speed necessary to accomplish the task.
- Check your blower before starting work. Pay special attention to the muffler, air intakes and air filter.

Vibrations

Prolonged use of the power tool may result in vibration-induced circulation problems in the hands (whitefinger disease).

No general recommendation can be given for the length of usage because it depends on several factors.

The period of usage is prolonged by:

- Keeping your hands warm
- Work breaks

The period of usage is shortened by:

- Any personal tendency to suffer from poor circulation (symptoms: frequently cold fingers, itching).
- Low outside temperatures.
- Gripping force (a tight grip hinders circulation).

Continual and regular users should monitor closely the condition of their hands and fingers. If any of the above

symptoms appear (e.g. tingling sensation in fingers), seek medical advice.

Maintenance and Repairs

Service the machine regularly. Do not attempt any maintenance or repair work not described in the instruction manual. Have all other work performed by a servicing dealer.

STIHL recommends that you have servicing and repair work carried out exclusively by an authorized STIHL servicing dealer. STIHL dealers are regularly given the opportunity to attend training courses and are supplied with the necessary technical information.

Only use high-quality replacement parts in order to avoid the risk of accidents and damage to the machine. If you have any questions in this respect, consult a servicing dealer.

STIHL recommends the use of genuine STIHL replacement parts. They are specifically designed to match your model and meet your performance requirements.

To reduce the risk of injury, **always shut off the engine** before carrying out any maintenance or repairs or cleaning the machine. – Exception: Carburetor and idle speed adjustments.

Do not turn the engine over on the starter with the spark plug boot or spark plug removed since there is otherwise a **risk of fire** from uncontained sparking.

Do not service or store your machine near open flames.

Check the fuel filler cap for leaks at regular intervals.

Use only a spark plug of the type approved by STIHL and make sure it is in good condition – see "Specifications".

Inspect the ignition lead (insulation in good condition, secure connection).

Check the condition of the muffler.

To reduce the **risk of fire and damage to hearing**, do not operate your machine if the muffler is damaged or missing.

Do not touch a hot muffler since **burn injury** will result.

Vibration behavior is influenced by the condition of the AV elements – check the AV elements at regular intervals.

Shut off the engine before rectifying problems.

Assembling the Blower

Mounting the Blower Tube

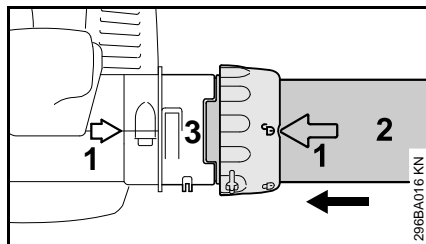

- Line up the arrows (1).
- Position the union nut so that the symbol  is in line with the arrows.
- Push the blower tube (2) into the fan housing stub (3) as far as stop.

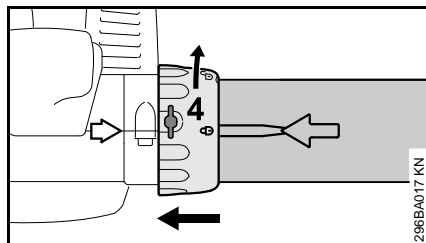

- Push the union nut (4) over the fan housing stub as far as stop.
- Rotate the union nut (4) in direction of arrow until symbol  is in line with the arrows – union nut snaps audibly into position.

BG 56, BG 86, SH 56, SH 86

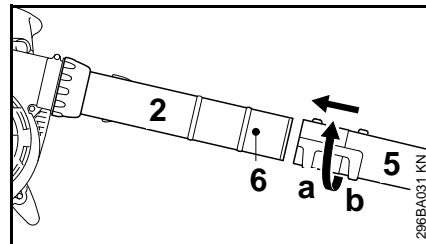

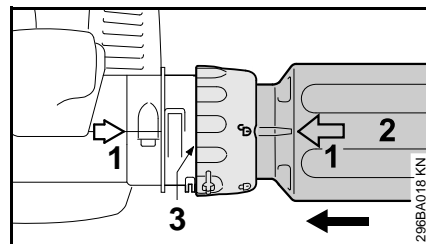

- Push nozzle (5) onto blower tube (2) as far as lug (6), position (a) (long) or position (b) (short), and rotate nozzle in direction of arrow to lock in position.

BG 66

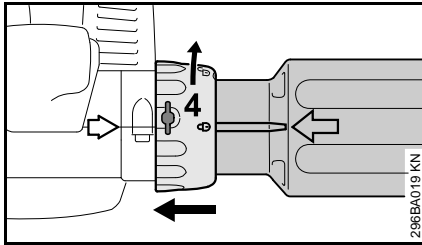

- Line up the arrows (1).
- Position the union nut so that the symbol  is in line with the arrows.
- Push the blower tube (2) into the fan housing stub (3) as far as stop.



- Push the union nut (4) over the fan housing stub as far as stop.
- Rotate the union nut (4) in direction of arrow until symbol  is in line with the arrows – union nut snaps audibly into position.

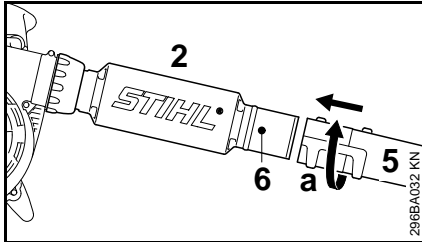

- Push nozzle (5) in position (a) onto the blower tube (2) as far as lug (6) and rotate in direction of arrow to lock in position.

Removing the Blower Tube

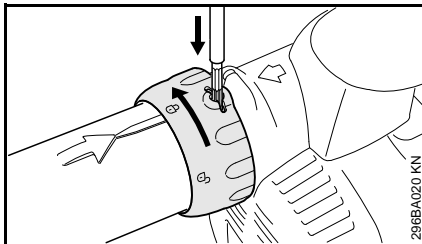

- Shut down the engine.

- Insert a suitable tool through the opening in the union nut to press down the tab.
- Rotate the union nut in the direction of the arrow as far as the stop.
- Remove the blower tube.

Assembling the Vacuum Shredder

Mounting the Elbow

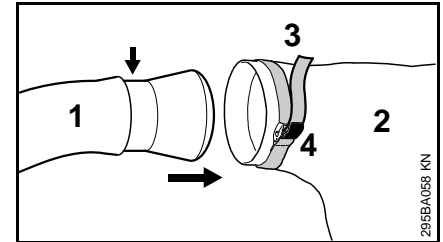



- Push the elbow (1) into the catcher bag (2) as far as the mark (smaller arrow).
- Tighten strap (3) on catcher bag and press down the tab (4).



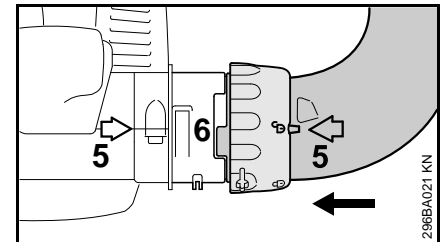

NOTICE

Make sure the zipper on the catcher bag is closed.

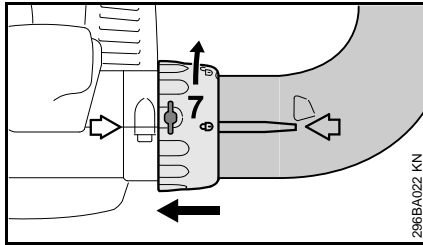

- Line up the arrows (5).
- Position the union nut so that the symbol  is in line with the arrows.
- Push the elbow into the recess in the fan housing stub (6) as far as stop.



- Push the union nut (7) over the fan housing stub as far as stop.
- Rotate the union nut (7) in direction of arrow until symbol  is in line with the arrows – union nut snaps audibly into position.

Assembling the Suction Tube

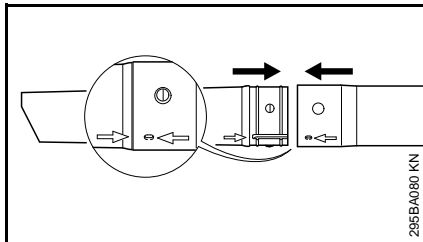

- Line up the arrows on the suction tube and extension tube. Push together and lock in position.

Mounting the Suction Tube

- Shut down the engine.

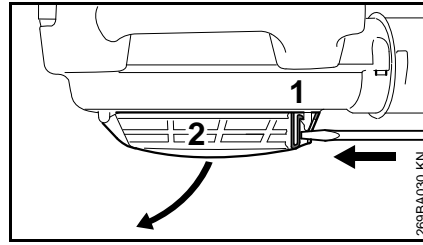

- Insert screwdriver in the tab (1) and press down to disengage the intake screen (2) and then open the intake screen.

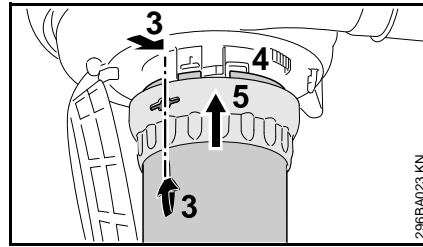

- Line up the arrows (3).
- Position union nut (5) so that the opening lines up with the arrows (3).
- Push the suction tube into the fan housing stub (4) as far as stop.
- Push the union nut (5) over the fan housing stub.

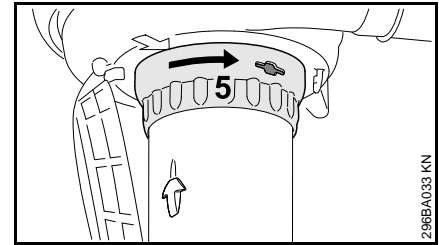

- Rotate union nut (5) in direction of arrow until it snaps audibly into position.
- Continue turning the union nut in direction of arrow and tighten it down firmly.

Removing the Elbow

- Shut down the engine.

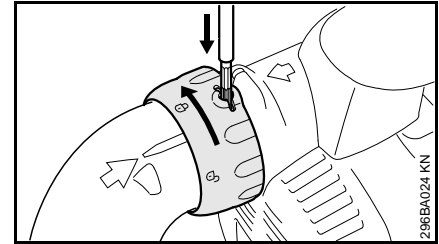

- Insert a suitable tool through the opening in the union nut to press down the tab.
- Rotate the union nut in the direction of the arrow as far as the stop.
- Remove the elbow.

Removing the Suction Tube

- Shut down the engine.

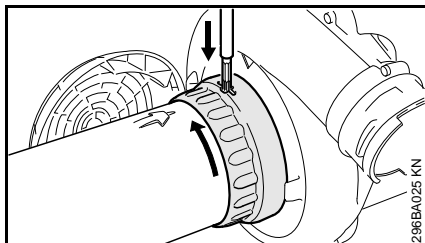

- Rotate the union nut in the direction of the arrow as far as the stop.
- Insert a suitable tool through the opening in the union nut to press down the tab.
- Continue turning the union nut in the direction of the arrow as far as the next stop.
- Remove the suction tube.
- Close the intake screen and lock it in position.

Fuel

Your engine requires a mixture of gasoline and engine oil.

WARNING

For health reasons, avoid direct skin contact with gasoline and avoid inhaling gasoline vapor.

STIHL MotoMix

STIHL recommends the use of STIHL MotoMix. This ready-to-use fuel mix contains no benzol or lead, has a high octane rating and ensures that you always use the right mix ratio.

STIHL MotoMix uses STIHL HP Ultra two-stroke engine oil for an extra long engine life.

MotoMix is not available in all markets.

Mixing Fuel

NOTICE

Unsuitable fuels or lubricants or mix ratios other than those specified may result in serious damage to the engine. Poor quality gasoline or engine oil may damage the engine, sealing rings, hoses and the fuel tank.

Gasoline

Use only high-quality **brand-name** gasoline with a minimum octane rating of 90 – leaded or unleaded.

If your machine is equipped with a catalytic converter, you must use unleaded gasoline.

NOTICE

A few tankfuls of leaded gasoline will greatly reduce the efficiency of the catalytic converter.

Gasoline with an ethanol content of more than 10% can cause running problems in engines with a manually adjustable carburetor and should not be used in such engines.

Engines equipped with M-Tronic deliver full power when run on gasoline with an ethanol content of up to 25% (E25).

Engine oil

Use only high-quality two-stroke engine oil – preferably **STIHL HP, HP Super or HP Ultra, which are specially formulated for use in STIHL engines. HP Ultra guarantees high performance and a long engine life.**

These engine oils are not available in all markets.

Use only **STIHL 50:1 two-stroke engine oil** for the fuel mix in models with a catalytic converter.

Mix Ratio

STIHL 50:1 two-stroke engine oil: 50 parts gasoline to 1 part oil

Examples

Gasoline	STIHL engine oil 50:1	
Liters	Liters	(ml)
1	0.02	(20)
5	0.10	(100)
10	0.20	(200)
15	0.30	(300)
20	0.40	(400)
25	0.50	(500)

- Use a canister approved for storing fuel. Pour oil into canister first, then add gasoline and mix thoroughly.

Storing Fuel

Store fuel only in approved safety-type fuel canisters in a dry, cool and safe location protected from light and the sun.

Fuel mix ages – only mix sufficient fuel for a few weeks work. Do not store fuel mix for longer than 30 days. Exposure to light, the sun, low or high temperatures can quickly make the fuel mix unusable.

STIHL MotoMix may be stored for up to 2 years without any problems.

- Thoroughly shake the mixture in the canister before fueling your machine.



WARNING

Pressure may build up in the canister – open it carefully.

- Clean the fuel tank and canister from time to time.

Dispose of remaining fuel and cleaning fluid properly in accordance with local regulations and environmental requirements.

Fueling



Preparations

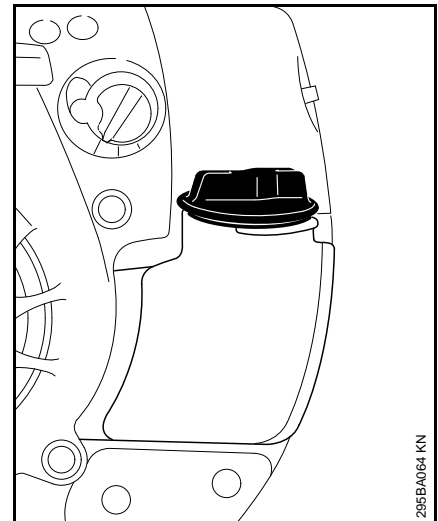

- Before fueling, clean the filler cap and the area around it to ensure that no dirt falls into the tank.
- Position the machine so that the filler cap is facing up.

STIHL recommends you use the STIHL filler nozzle for fuel (special accessory).

Fill up with fuel

Take care not to spill fuel while fueling and do not overfill the tank.

- Open the filler cap.
- Fill up with fuel
- Closing the cap

! WARNING

After fueling, tighten down the filler cap as securely as possible.

Changing the fuel pickup body

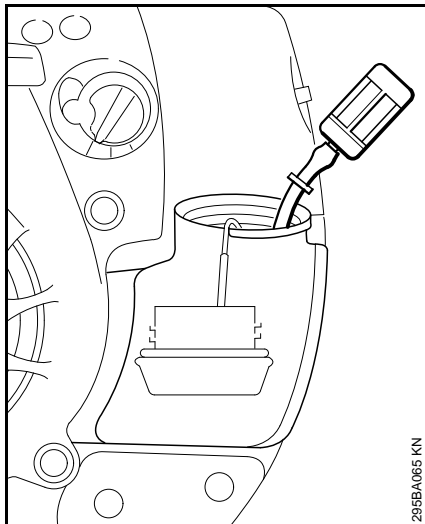

Change the fuel pick up body every year.

- Drain the fuel tank.
- Use a hook to pull the fuel pickup body out of the tank and take it off the hose.
- Push the new pickup body into the hose.
- Place the pickup body in the tank.

Starting / Stopping the Engine

Starting the Engine

- Observe safety precautions.

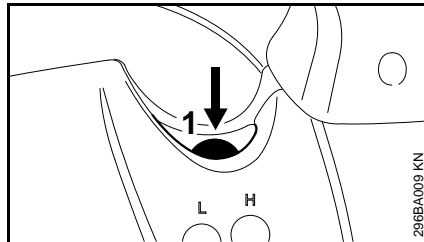

- Press the manual fuel pump bulb (1) at least five times – even if the bulb is filled with fuel.

Adjusting the setting lever

Only on BG 66 C, BG 86, SH 86

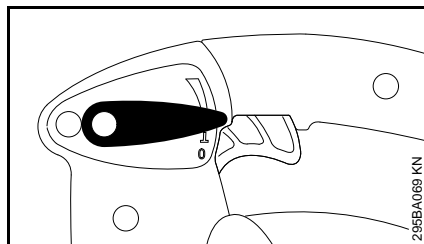

- To start, move the setting lever to the run position **I**

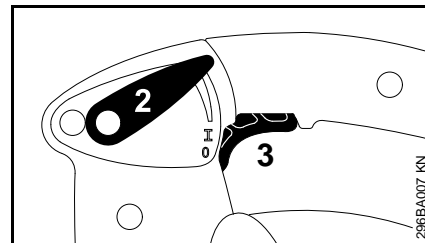

The setting lever (2) allows the throttle trigger (3) to be locked in any required position during operation.

Adjusting the choke knob

If the engine is cold

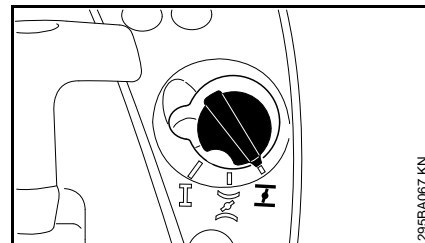

- Turn the choke knob to **I**

If the engine is warm

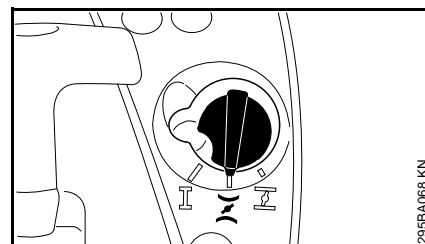

- Turn the choke knob to **II**

Also use this setting if the engine has been running but is still cold.

Cranking

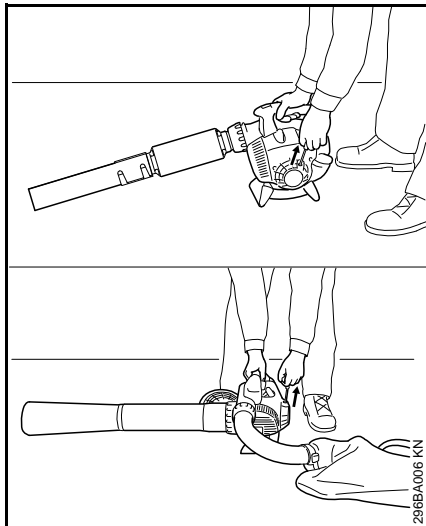

- Place the unit on the ground so that it is secure.
- Make sure you have a firm footing: Hold the unit firmly with your right hand on the housing and press down.
- Hold the starter grip with your left hand.

Version with ErgoStart

- Pull the starter grip steadily.

Version without ErgoStart

- Pull the starter grip slowly until you feel it engage and then give it a brisk strong pull.



NOTICE

Do not pull out the starter rope all the way – it might otherwise break.

- Do not let the starter grip snap back. Guide it slowly back into the housing so that the starter rope can rewind properly.

As Soon as Engine Runs

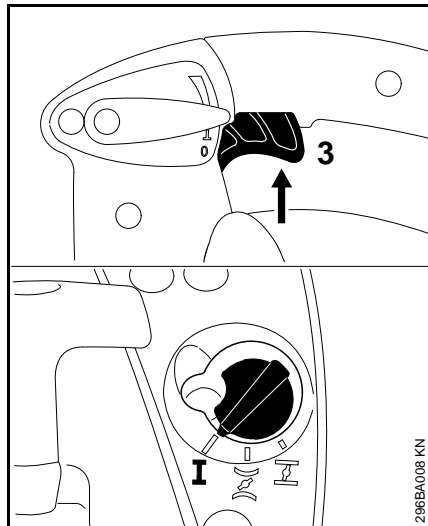

- Blip the throttle trigger (3) – the choke knob moves to the run position **I** – the engine returns to idle speed.

Stopping the Engine

BG 56, BG 66, SH 56

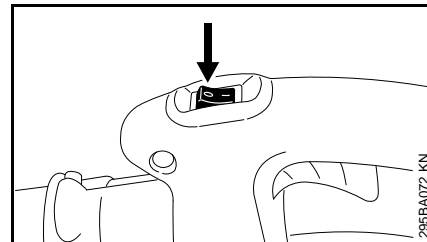

- Move the stop switch to **0** – the engine stops – the stop switch springs back to the on position.

BG 66 C, BG 86, SH 86

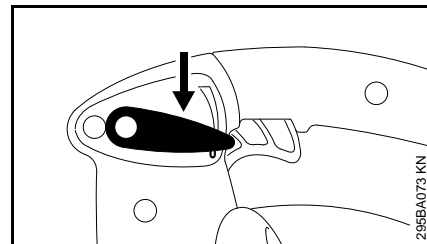

- Move the setting lever to **0** – the engine stops – the setting lever springs back to the on position.

Other Hints on Starting

If the engine stops in position **I** or during acceleration

- Move the choke lever to **I** and continue cranking until the engine runs.

If engine does not start

- Make sure all settings are correct (choke knob, setting lever in run position I).
- Repeat the starting procedure.

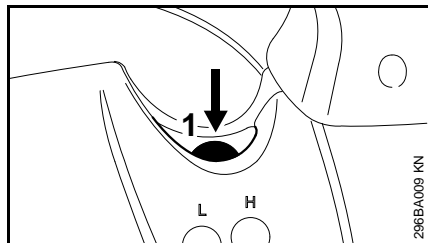
If fuel tank has been run completely dry and then refueled

- Press the manual fuel pump bulb (1) at least five times – even if the bulb is filled with fuel.
- Now start the engine.

Cleaning the Air Filter

Dirty air filters reduce engine power, increase fuel consumption and make starting more difficult.

Different Air Filters

Different models are equipped with different air filters. The models can be identified by the filter housing and the air filter itself.

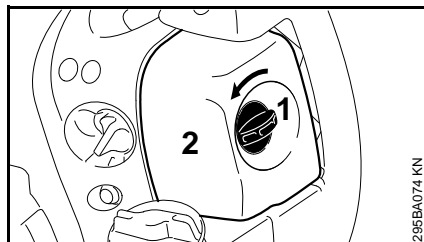
Version with Flat Filter Material

- Turn the filter cover lock (1) counterclockwise to the vertical position.
- Remove the filter cover (2).
- Clean away loose dirt from around the filter.

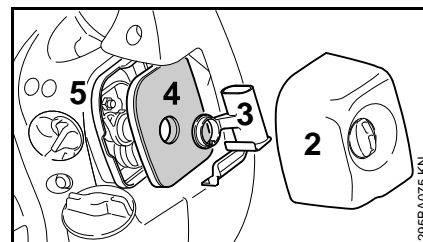

- Pull off the retainer (3) and take the air filter element (4) out of the filter housing (5).
- Replace the filter element. As a temporary measure you can knock it out on the palm of your hand or blow it out with compressed air – do not wash.

Replace any damaged parts.

Installing the filter element

- Fit the filter (4) in the filter housing (5) and push the retainer (3) into position.
- Refit the filter cover (2) and turn the filter cover lock clockwise to the horizontal position.

Version with Pleated Filter Material

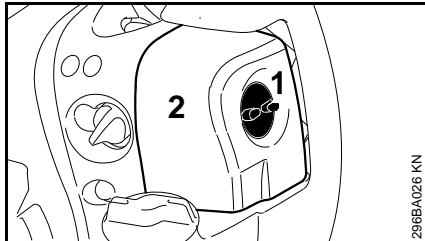

- Unscrew the filter cover lock (1) counterclockwise.
- Remove the filter cover (2).
- Clean away loose dirt from around the filter.

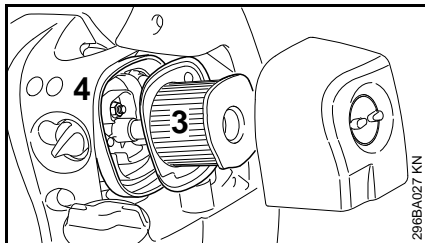

- Take the air filter (3) out of the filter housing (4).

Cleaning the air filter

- Carefully knock the filter out on the palm of your hand or blow it clear with compressed air from the inside outwards.

In case of stubborn dirt or sticky filter fabric

- Wash the air filter in STIHL special cleaner (special accessory) or a clean, non-flammable solution (e.g. warm soapy water). Rinse the filter

from the inside outwards under a jet of water – do not use a pressure washer.

- Dry the filter – do not expose to high temperatures.

Place the filter in position.

- Install the filter element in the filter housing.
- Fit the filter cover and tighten the filter cover lock clockwise.

Adjusting the Carburetor

General Information

The carburetor comes from the factory with a standard setting.

This setting provides an optimum fuel-air mixture under most operating conditions.

Preparations

- Shut off the engine.
- Check the air filter and clean or replace if necessary.
- Check the spark arresting screen in the muffler and clean or replace if necessary.

Standard Setting

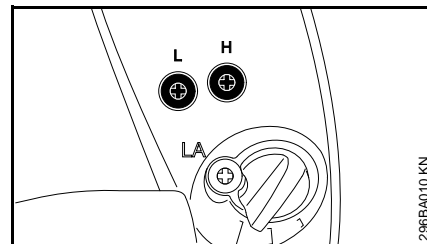

- Turn high speed screw (H) counterclockwise as far as stop (no more than 3/4 turn).
- Turn the low speed screw (L) clockwise as far as stop, then turn it back 3/4 turn.

Adjusting Idle Speed

- Carry out the standard setting.
- Start and warm up the engine.

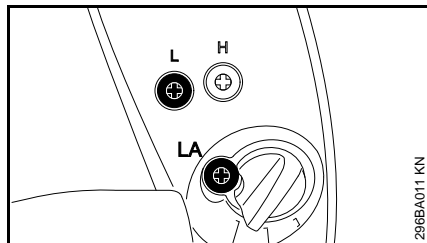

Engine stops while idling

- Turn the idle speed screw (LA) clockwise until the engine runs smoothly.

Erratic idling behavior, poor acceleration (despite correction to setting of LA screw).

Idle setting is too lean

- Turn the low speed screw (L) carefully counterclockwise, no further than stop, until the engine runs smoothly and accelerates well.

Erratic idling behavior, engine speed drops when swinging the machine

Idle setting is too rich

- Turn the low speed screw (L) clockwise (1/8 of a turn or 45° at a time) until the engine runs smoothly and still accelerates well.

It is usually necessary to change the setting of the idle speed screw (LA) after every correction to the low speed screw (L).

Fine Tuning for Operation at High Altitude

A slight correction of the setting may be necessary if the engine does not run satisfactorily:

- Carry out the standard setting.
- Warm up the engine.
- Turn high speed screw (H) slightly clockwise (leaner) – no further than stop.

NOTICE

After returning from high altitude, reset the carburetor to the standard setting.

If the setting is too lean there is a risk of engine damage due to insufficient lubrication and overheating.

Spark Plug

- If the engine is down on power, difficult to start or runs poorly at idle speed, first check the spark plug.
- Fit a new spark plug after about 100 operating hours – or sooner if the electrodes are badly eroded. Install only suppressed spark plugs of the type approved by STIHL – see "Specifications".

Removing the spark plug

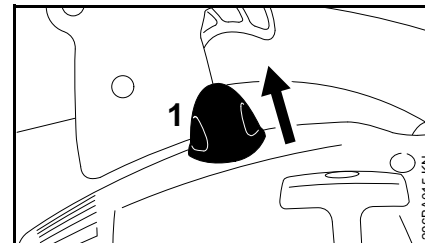

- Pull off the spark plug boot (1).
- Unscrew the spark plug.

Checking the Spark Plug

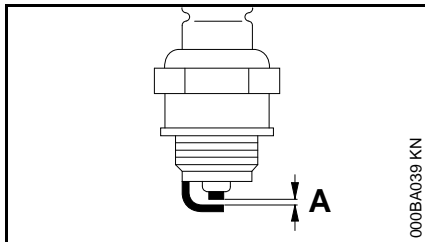

- Clean dirty spark plug.
- Check electrode gap (A) and readjust if necessary – see "Specifications".
- Rectify the problems which have caused fouling of the spark plug.

Possible causes are:

- Too much oil in fuel mix.
- Dirty air filter.
- Unfavorable running conditions.

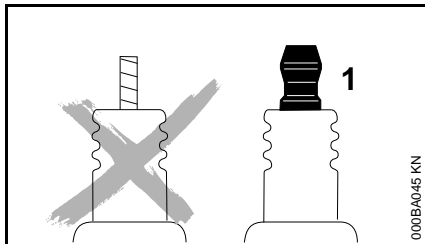

WARNING

Arcing may occur if the adapter nut (1) is loose or missing. Working in an easily combustible or explosive atmosphere may cause a fire or an explosion. This can result result in serious injuries or damage to property.

- Use resistor type spark plugs with a properly tightened adapter nut.

Installing the spark plug

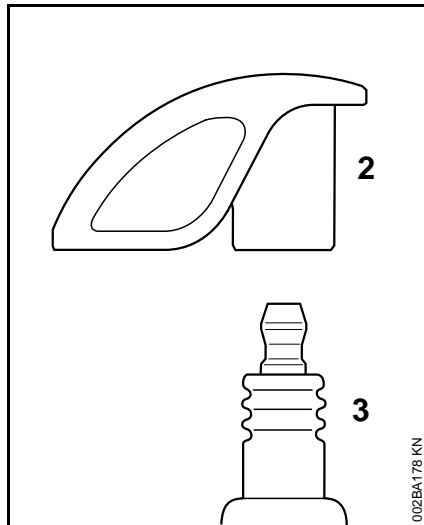

- Screw the spark plug (3) into the cylinder and fit the boot (2) (press it down firmly).

Engine Running Behavior

If engine running behavior is unsatisfactory even though the air filter is clean and the carburetor is properly adjusted, the cause may be the muffler.

Have the muffler checked for contamination (carbonization) by your servicing dealer.

STIHL recommends that you have servicing and repair work carried out exclusively by an authorized STIHL servicing dealer.

Storing the Machine

For periods of 3 months or longer

- Drain and clean the fuel tank in a well ventilated area.
- Dispose of fuel properly in accordance with local environmental requirements.
- Run the engine until the carburetor is dry – this helps prevent the carburetor diaphragms sticking together.
- Thoroughly clean the machine – pay special attention to the cylinder fins and air filter.
- Store the machine in a dry, high or locked location, – out of the reach of children and other unauthorized persons.

Inspections and Maintenance by Dealer

Spark Arresting Screen in Muffler

- If the engine is down on power, check the spark arresting screen in the muffler.

STIHL recommends that you have servicing and repair work carried out exclusively by an authorized STIHL servicing dealer.

Maintenance and Care

The following intervals apply to normal operating conditions only. If your daily working time is longer or operating conditions are difficult (very dusty work area, etc.), shorten the specified intervals accordingly.		before starting work	after finishing work or daily	after each refueling stop	weekly	monthly	every 12 months	if problem	if damaged	as required
Complete machine	Visual inspection (condition, wear, leaks)	X		X						
	Clean		X							
	Replace any damaged parts	X								
Control handle	Check operation	X		X						
Air filter	Visual inspection						X	X		
	Clean							X		X
	Replace								X	X
Manual fuel pump (if fitted)	Check	X								
	Have repaired by servicing dealer ¹⁾								X	
Pickup body in fuel tank	Check							X		
	Install new pickup body						X		X	X
Fuel tank	Clean							X		X
Carburetor	Check idle adjustment	X		X						
	Adjust idle speed									X
Spark plug	Adjust electrode gap							X		
	Replace after 100 operating hours									
Cooling inlets	Visual inspection		X							
	Clean									X

The following intervals apply to normal operating conditions only. If your daily working time is longer or operating conditions are difficult (very dusty work area, etc.), shorten the specified intervals accordingly.		before starting work	after finishing work or daily	after each refueling stop	weekly	monthly	every 12 months	if problem	if damaged	as required
Spark arrestor in muffler	Check ¹⁾							X		
	Have replaced by servicing dealer ¹⁾								X	X
All accessible screws and nuts (not adjusting screws)	Retighten									X
Anti-vibration elements ²⁾	Check	X						X		X
	Have replaced by servicing dealer ¹⁾								X	
Safety labels	Replace								X	

1) STIHL recommends an authorized STIHL servicing dealer

2) BG 66 C, BG 86, BG 86 C, SH 86, SH 86 C

Main Parts

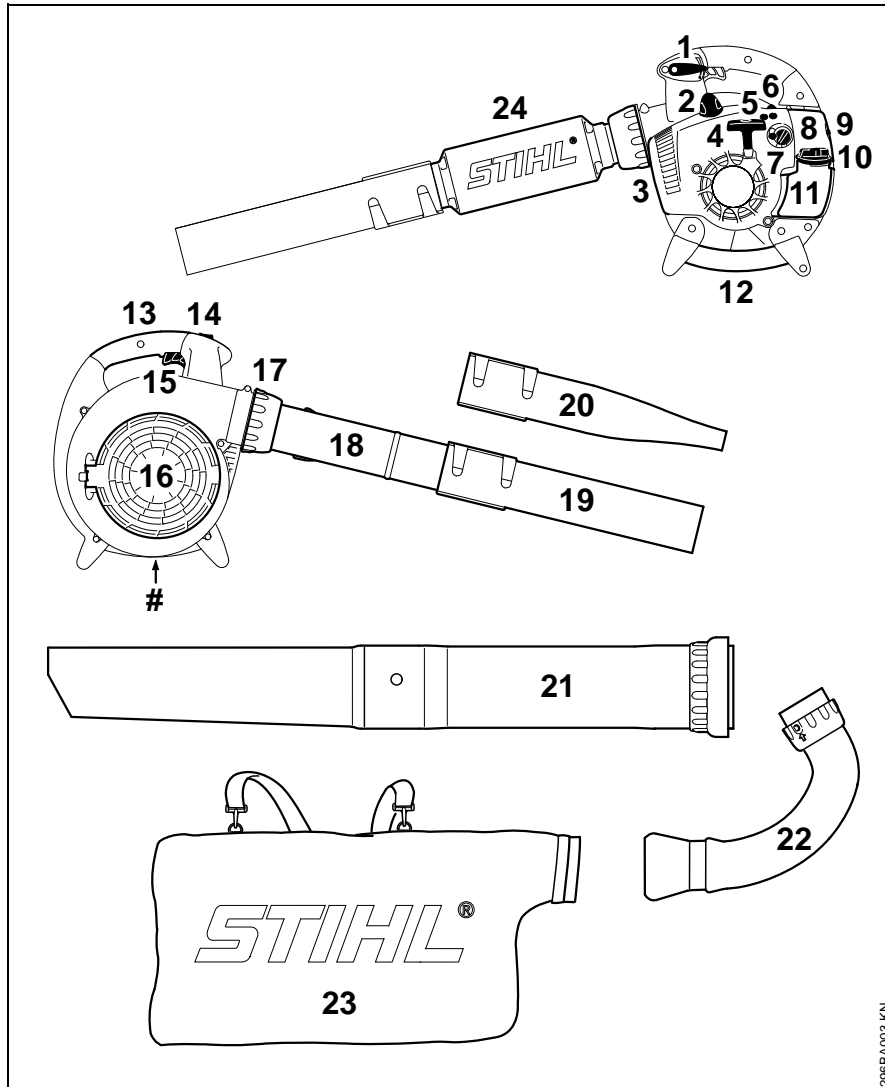

- 1 Setting lever (BG 66 C, BG 86, SH 86)
- 2 Spark plug boot
- 3 Muffler
- 4 Starter grip
- 5 Carburetor adjusting screws
- 6 Manual fuel pump
- 7 Choke knob
- 8 Filter cover
- 9 Filter cover lock
- 10 Tank cap
- 11 Fuel tank
- 12 Handle
- 13 Control handle
- 14 Stop switch (BG 56, BG 66, SH 56)
- 15 Throttle trigger
- 16 Protective screen
- 17 Union nut
- 18 Blower tube (BG 56, BG 86, SH 56)
- 19 Round nozzle
- 20 Fan nozzle *
- 21 Suction tube *
- 22 Elbow *
- 23 Catcher bag *
- 24 Blower tube silencer (BG 66)
- # Serial number

* Depending on version – special accessory

296BA003 KN

Specifications

Engine

Single cylinder two-stroke engine

Displacement: 27.2 cc

Bore: 34 mm

Stroke: 30 mm

Idle speed: 2,500 rpm

Engine power to
ISO 7293:

BG 56: 0.7 kW (1.0 bhp)

BG 66: 0.6 kW (0.8 bhp)

BG 86: 0.8 kW (1.1 bhp)

SH 56: 0.7 kW (1.0 bhp)

SH 86: 0.8 kW (1.1 bhp)

Ignition System

Electronic magneto ignition

Spark plug (resistor
type): NGK CMR 6 H

Electrode gap: 0.5 mm

Fuel System

All position diaphragm carburetor with
integral fuel pump

Fuel tank capacity:

BG 56: 540 cc (0.54 l)

BG 66: 540 cc (0.54 l)

BG 66 C: 440 cc (0.44 l)

BG 86: 440 cc (0.44 l)

SH 56: 540 cc (0.54 l)

SH 86: 440 cc (0.44 l)

Blowing performance

Blowing force (round nozzle)

BG 56: 13 N

BG 66: 10 N

BG 86: 15 N

SH 56: 15 N

SH 86: 15 N

Air velocity (blower mode)

Blower mode (round nozzle)

BG 56: 60 m/s

BG 66: 51 m/s

BG 86: 63 m/s

SH 56: 60 m/s

SH 86: 63 m/s

Blower mode (fan nozzle)

BG 86: 74 m/s

SH 86: 74 m/s

Air flow rate

	Round nozzle	Fan nozzle
BG 56:	700 m ³ /h	---
BG 66:	630 m ³ /h	---
BG 86:	755 m ³ /h	620 m ³ /h
SH 56:	700 m ³ /h	560 m ³ /h
SH 86:	755 m ³ /h	620 m ³ /h

Maximum air velocity (blower mode, round nozzle)

BG 56: 71 m/s

BG 66: 62 m/s

BG 86: 76 m/s

SH 56: 71 m/s

SH 86: 76 m/s

Maximum air flow rate (without blower tube assembly)

BG 56: 730 m³/h

BG 66: 730 m³/h

BG 86: 810 m³/h

SH 56: 730 m³/h

SH 86: 810 m³/h

Weight

Dry, blower mode

BG 56: 4.1 - 4.2 kg^{*)}

BG 66: 4.4 kg

BG 66 C: 4.7 kg

BG 86: 4.4 - 4.5 kg^{*)}

^{*)} According to equipment

Dry, vacuum mode

SH 56: 5.2 kg

SH 86: 5.6 kg

Noise and Vibration Data

For further details on compliance with
Vibration Directive 2002/44/EC see
www.stihl.com/vib.

**Sound pressure level L_{peq} to
DIN EN 15503**

	Blower mode	Vacuum mode
BG 56:	90 dB(A)	94 dB(A)
BG 66:	86 dB(A)	- - -
BG 86:	90 dB(A)	93 dB(A)
SH 56:	90 dB(A)	94 dB(A)
SH 86:	90 dB(A)	93 dB(A)

Sound power level L_w to DIN EN 15503

	Blower mode	Vacuum mode
BG 56:	104 dB(A)	105 dB(A)
BG 66:	98 dB(A)	- - -
BG 86:	104 dB(A)	106 dB(A)
SH 56:	104 dB(A)	105 dB(A)
SH 86:	104 dB(A)	106 dB(A)

**Vibration measurement $a_{hv, eq}$ to
DIN EN 15503****Blower mode**

	Handle, right
BG 56:	7.5 m/s ²
BG 66:	7.8 m/s ²
BG 66 C:	2.1 m/s ²
BG 86:	2.5 m/s ²
SH 56:	7.5 m/s ²
SH 86:	2.5 m/s ²

Vacuum mode

	Handle, left	Handle, right
BG 56:	8.5 m/s ²	7.5 m/s ²
BG 86:	2.5 m/s ²	1.9 m/s ²
SH 56:	8.5 m/s ²	7.5 m/s ²
SH 86:	2.5 m/s ²	1.9 m/s ²

The K-factor in accordance with Directive 2006/42/EC is 2.5 dB(A) for the sound pressure level and sound power level; the K-factor in accordance with Directive 2006/42/EC is 2.0 m/s² for the vibration measurement.

REACH

REACH is an EC regulation and stands for the Registration, Evaluation, Authorisation and Restriction of Chemical substances.

For information on compliance with the REACH regulation (EC) No. 1907/2006 see www.stihl.com/reach.

Maintenance and Repairs

Users of this machine may only carry out the maintenance and service work described in this user manual. All other repairs must be carried out by a servicing dealer.

STIHL recommends that you have servicing and repair work carried out exclusively by an authorized STIHL servicing dealer. STIHL dealers are regularly given the opportunity to attend training courses and are supplied with the necessary technical information.

When repairing the machine, only use replacement parts which have been approved by STIHL for this power tool or are technically identical. Only use high-quality replacement parts in order to avoid the risk of accidents and damage to the machine.

STIHL recommends the use of original STIHL replacement parts.

Original STIHL parts can be identified by the STIHL part number, the **STIHL** logo and the STIHL parts symbol  (the symbol may appear alone on small parts).

Disposal

Observe all country-specific waste disposal rules and regulations.

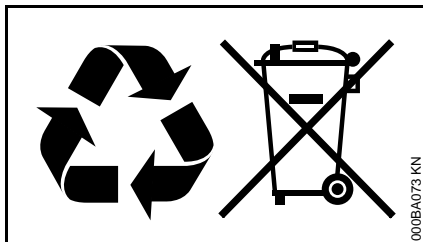

STIHL products must not be thrown in the garbage can. Take the product, accessories and packaging to an approved disposal site for environment-friendly recycling.

Contact your STIHL servicing dealer for the latest information on waste disposal.

EC Declaration of Conformity

ANDREAS STIHL AG & Co. KG
Badstr. 115
D-71336 Waiblingen

Germany

declare in exclusive responsibility that the product

Category: Blower, vacuum shredder
Make: STIHL
Model: BG 56
BG 56 C
BG 56 C-E
BG 66
BG 66 C
BG 66 C-E
BG 86
BG 86 C
BG 86 C-E
SH 56
SH 56 C
SH 56 C-E
SH 86
SH 86 C
SH 86 C-E

Serial identification: 4241
Displacement: 27.2 cc

conforms to the relevant provisions of Directives 2006/42/EC, 2014/30/EU and 2000/14/EC and has been developed and manufactured in compliance with the following standards in the versions valid on the date of production:

EN ISO 12100, EN 15503, EN 55012, EN 61000-6-1

The measured and guaranteed sound power levels were determined according to Directive 2000/14/EC, Annex V, using the ISO 11094 standard.

Measured sound power level

all BG 56: 102 dB(A)
all BG 66: 99 dB(A)
all BG 86: 102 dB(A)
all SH 56: 103 dB(A)
all SH 86: 103 dB(A)

Guaranteed sound power level

all BG 56: 104 dB(A)
all BG 66: 101 dB(A)
all BG 86: 104 dB(A)
all SH 56: 105 dB(A)
all SH 86: 105 dB(A)

Technical documents deposited at:

ANDREAS STIHL AG & Co. KG
Produktzulassung (Product Licensing)

The year of manufacture and serial number are applied to the product.

Done at Waiblingen, 28.10.2016

ANDREAS STIHL AG & Co. KG

Thomas Elsner

Director Product Management and Services

0458-296-8321-D

AUS



www.stihl.com



0458-296-8321-D